

Grounding for leads 5.2–35 mm<sup>2</sup> / 10–2 AWG

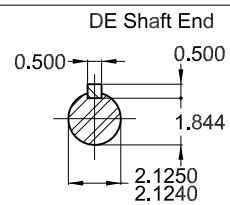
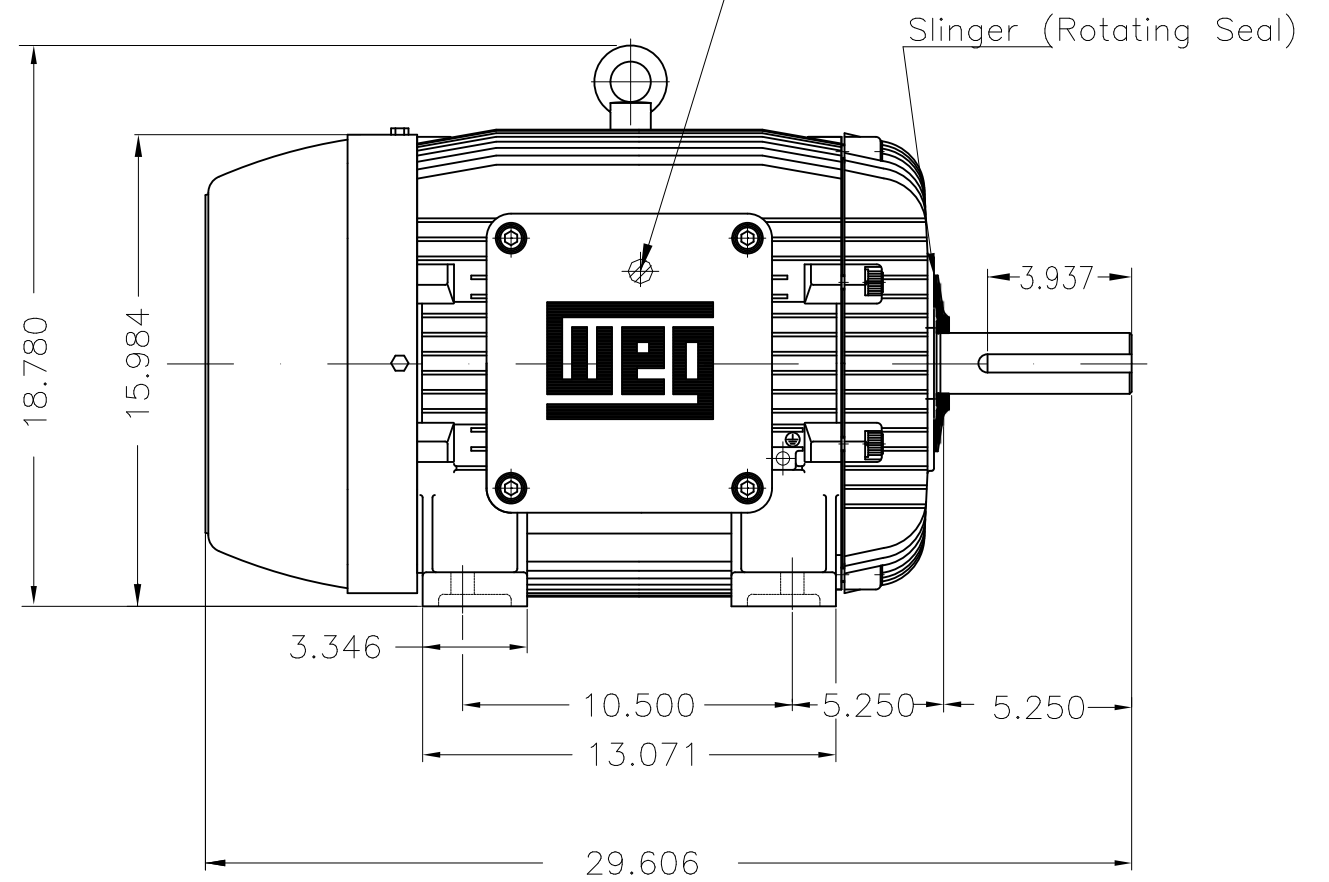

Color RAL 5009  
 Painting plan 222P  
 Mounting NEMA F-1  
 Mounting B3R(D)

40 HP 04 Poles 60 Hz

ECM		LOC	SUMMARY OF MODIFICATIONS		HYBRISUSER					00
EXECUTED	HYBRISUSER		THREE PH. MOTOR EXPLOSION PROOF NEMA PREM. EFF.		EXECUTED	CHECKED	RELEASED	DATE	VER	
CHECKED			FRAME 324T IP55 TEFC							
RELEASED										
REL. DATE		WMO	Jaragua do Sul	Product Engineering						

PREVIEW

WDD 00

SHEET 1 / 1

