

Grounding for leads 2-10 mm<sup>2</sup> / 14-7 AWG

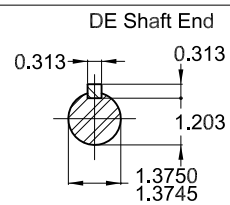
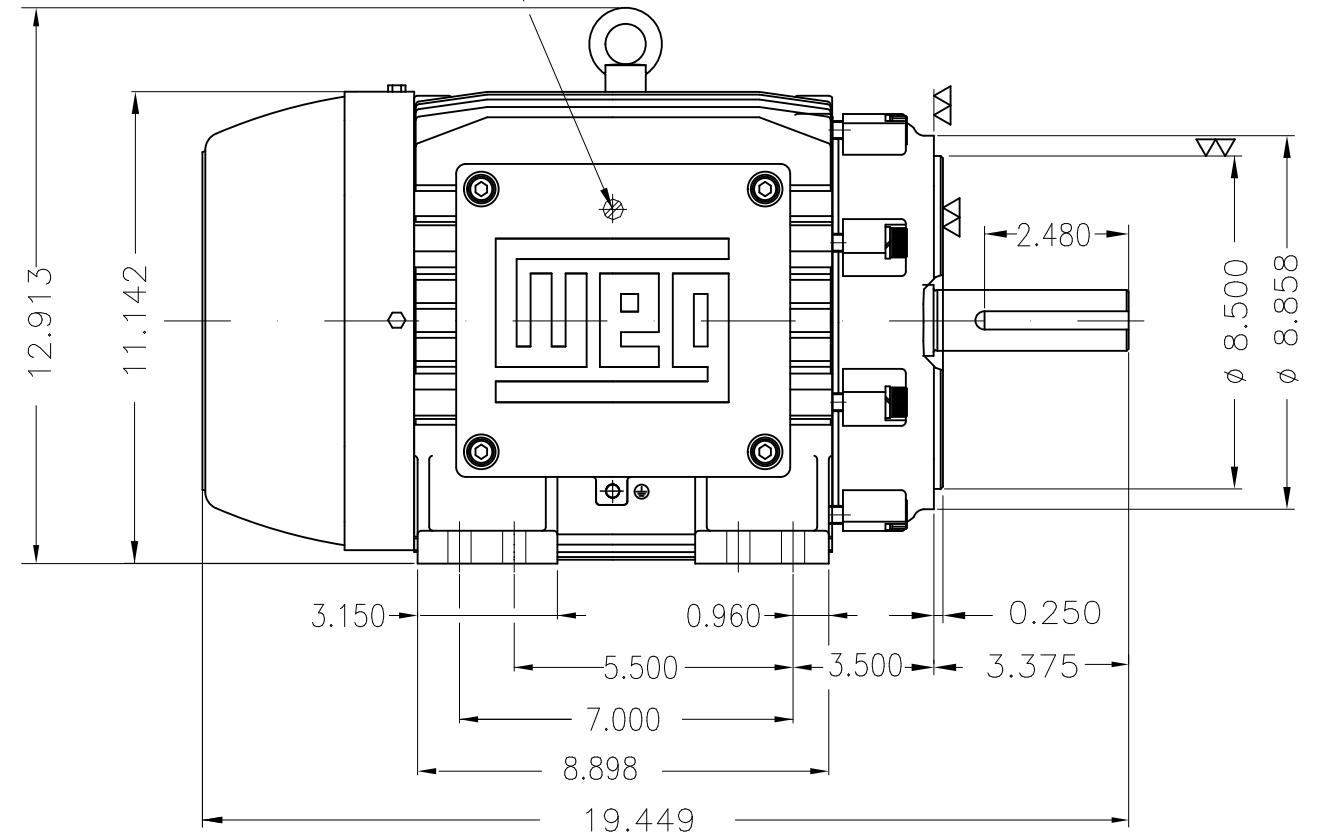

Color RAL 5009  
 Painting plan 202P  
 Mounting NEMA F-1  
 Mounting B34R(D)

5 HP 06 Poles 60 Hz

ECM		LOC	SUMMARY OF MODIFICATIONS		HYBRISUSER						00
EXECUTED	HYBRISUSER		THREE PH. MOTOR EXPLOSION PROOF NEMA PREM. EFF.		EXECUTED	CHECKED	RELEASED	DATE	VER		
CHECKED			FRAME 213/5TC IP55 TEFC								
RELEASED											
REL. DATE		WMO	Jaragua do Sul	Product Engineering							

PREVIEW

WDD 00

SHEET 1 / 1

