

1 2 3 4 5 6

A

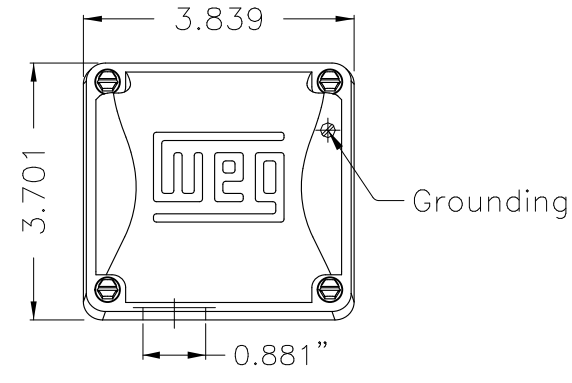

B

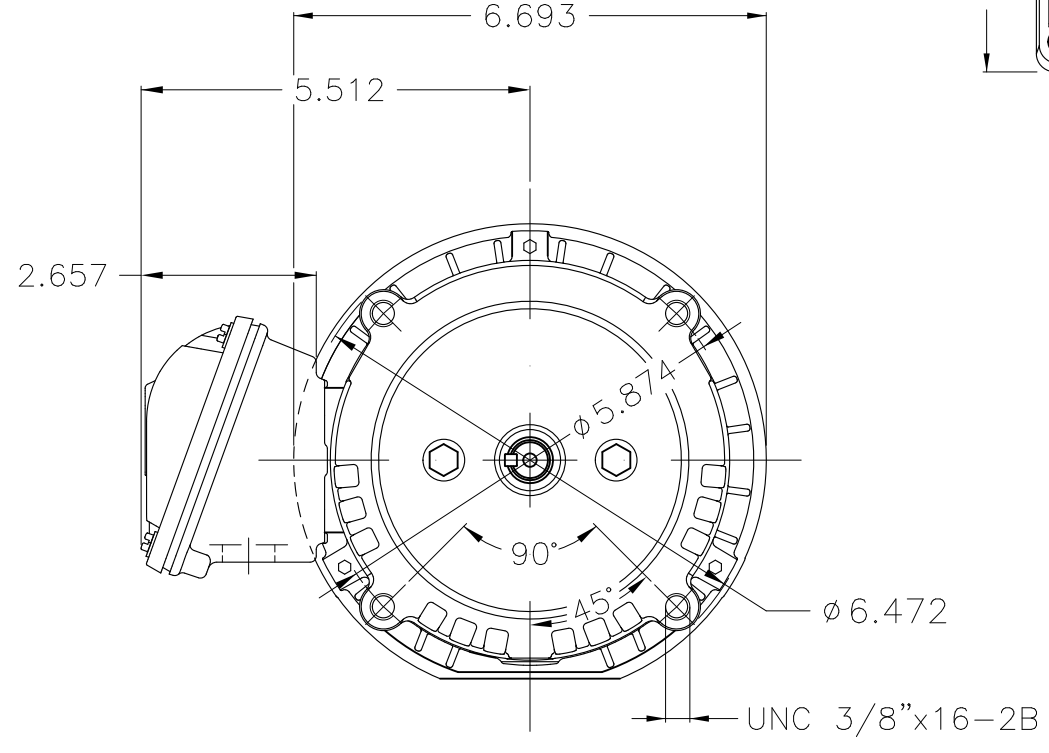

C

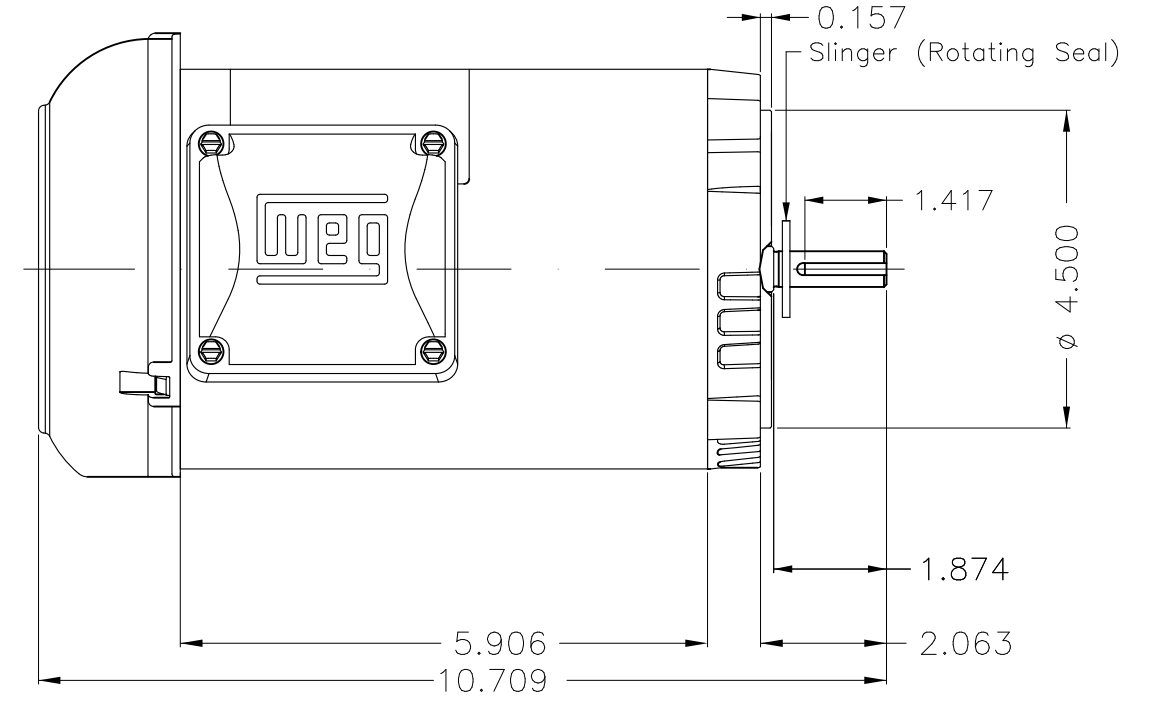

D

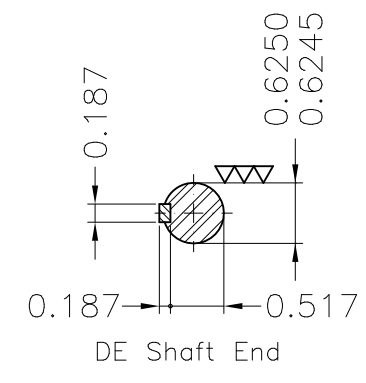

E

NDE sealing - V ring  
 Color Munsell N 1 matte black  
 Painting plan 207N  
 Mounting W-6/V18R(D)

						HYBRISUSER				00	
ECM	LOC	SUMMARY OF MODIFICATIONS				EXECUTED	CHECKED	RELEASED	DATE	VER	
EXECUTED	HYBRISUSER	THREE PH. MOTOR ROLLED STEEL JET PUMP KEYED PREM 555				EXECUTED					
CHECKED		FRAME W56C IP55 TEFC									
RELEASED											
REL. DATE		WMO	Jaragua do Sul	Product Engineering							

0.75 HP 02 Poles 60 Hz

**A** WDD 00 SHEET 1 / 1

