

1 2 3 4 5 6

A

B

C

D

E

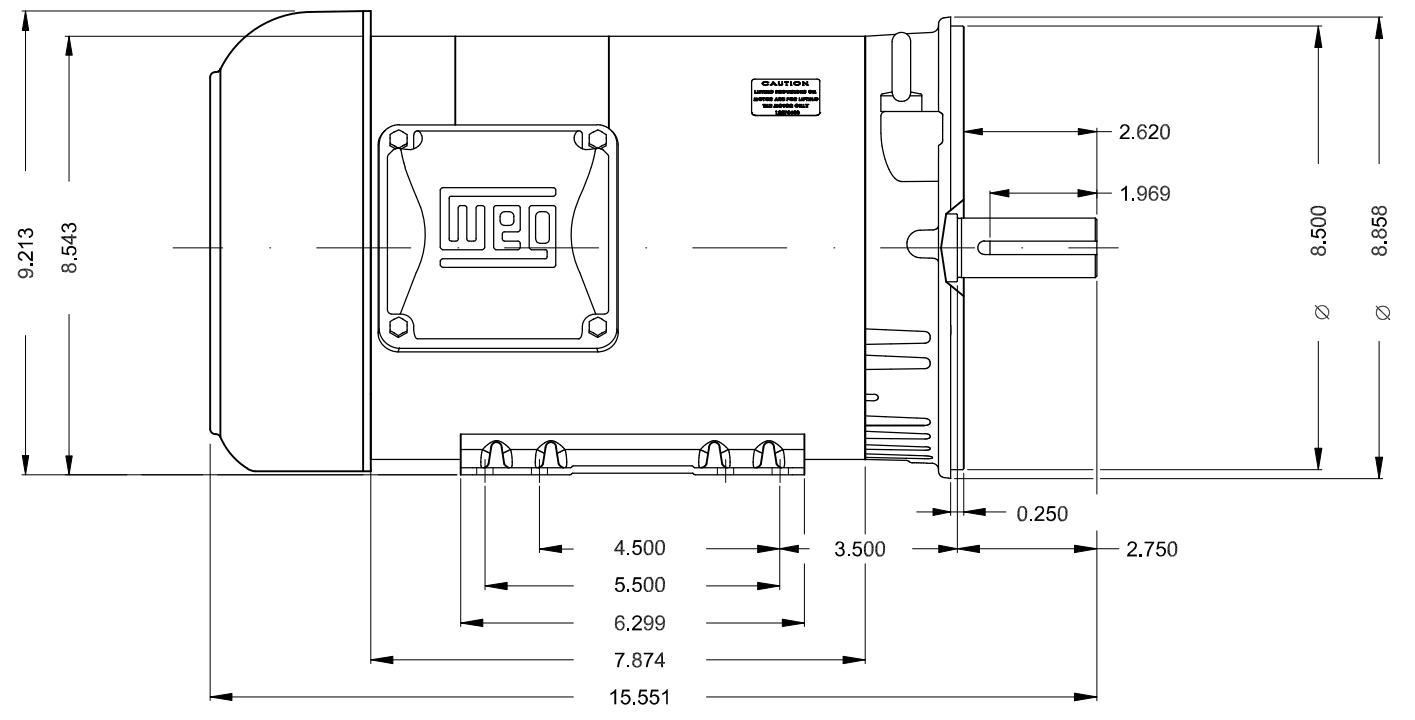
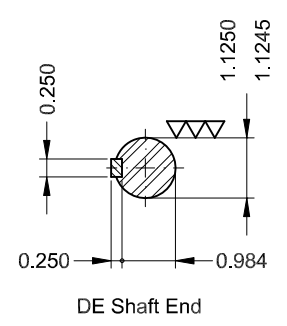
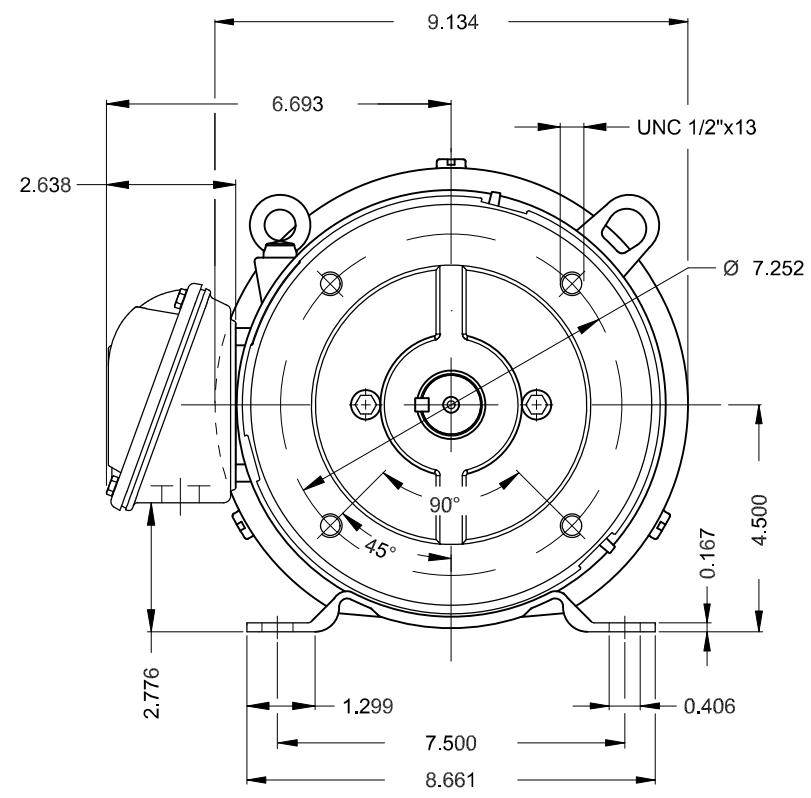
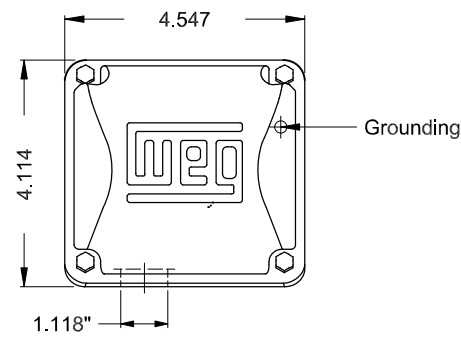

Color Munsell N 1 matte black									
Painting plan 207N									
Mounting B34D									
					HYBRISUSER	00			
ECM	LOC	SUMMARY OF MODIFICATIONS			EXECUTED	CHECKED	RELEASED	DATE	VER
EXECUTED	HYBRISUSER	THREE PH. MOTOR ROLLED STEEL NEMA PREM. EFF.				PREVIEW			
CHECKED		FRAME 182/4TC IP55 TEFC				WDD	00		
RELEASED						SHEET	1 / 1		
REL. DATE		WMO	Jaragua do Sul	Product Engineering					

3 HP 02 Poles 60 Hz

A