

A

B

C

D

E

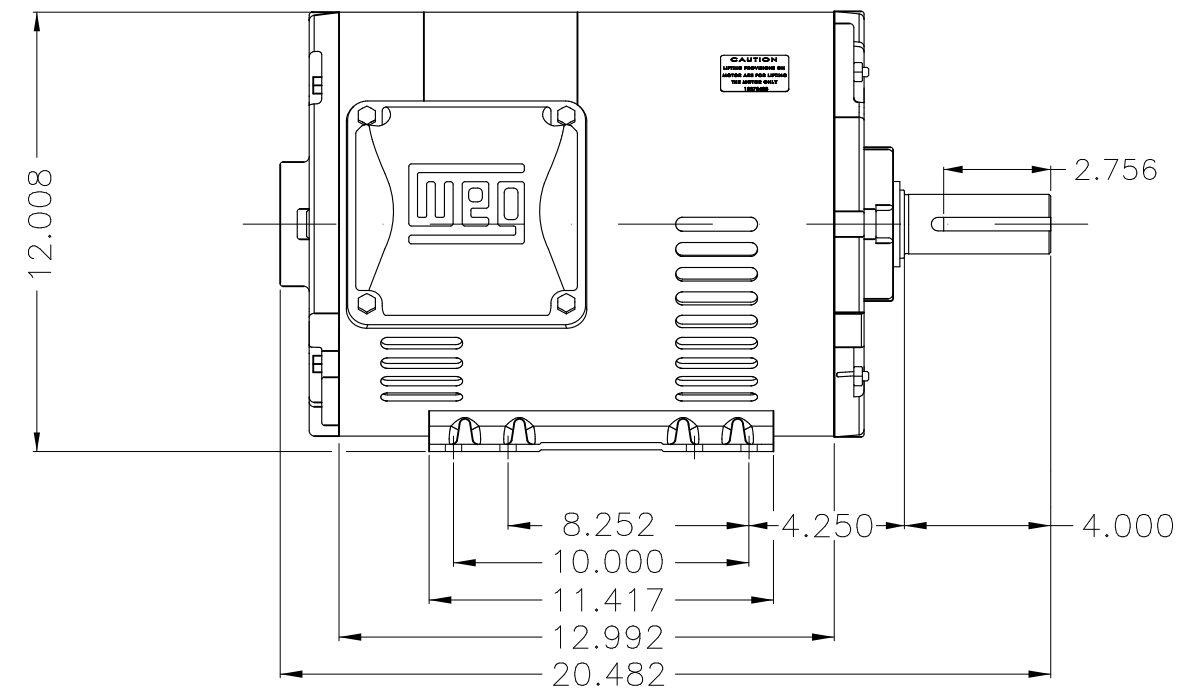
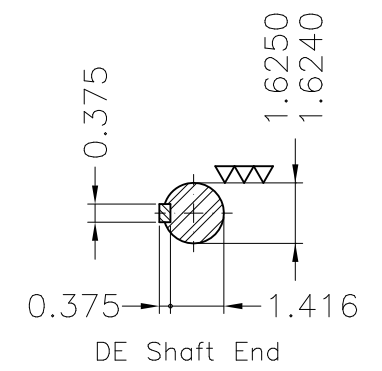
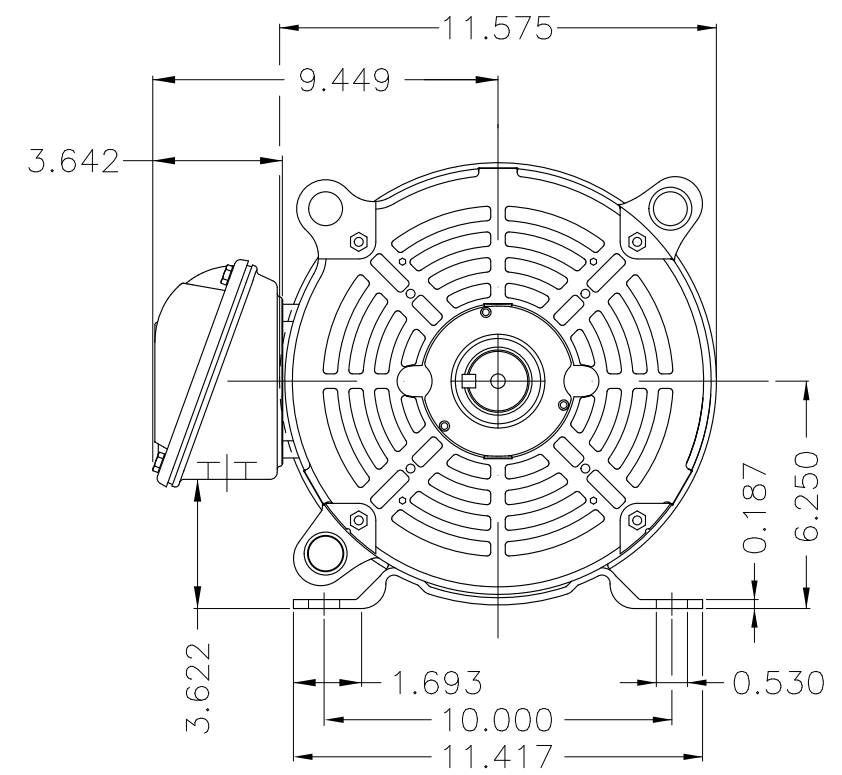
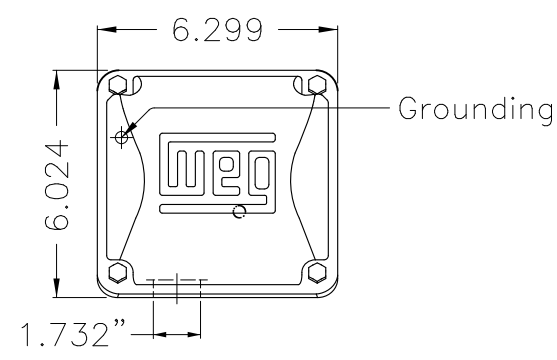

Color Munsell N 1 matte black									
Painting plan 207N									
Mounting F-1/B3R(D)									
					HYBRISUSER	00			
ECM	LOC	SUMMARY OF MODIFICATIONS			EXECUTED	CHECKED	RELEASED	DATE	VER
EXECUTED	HYBRISUSER	THREE PH. MOTOR ROLLED STEEL NEMA PREM. EFF.				PREVIEW WDD 00			
CHECKED		FRAME 254/6T IP21 ODP							
RELEASED									
REL. DATE		WMO	Jaragua do Sul	Product Engineering	SHEET	1 / 1			

10 HP 06 Poles 60 Hz

A