

Grounding for leads 25-50 mm² / 3-1 AWG

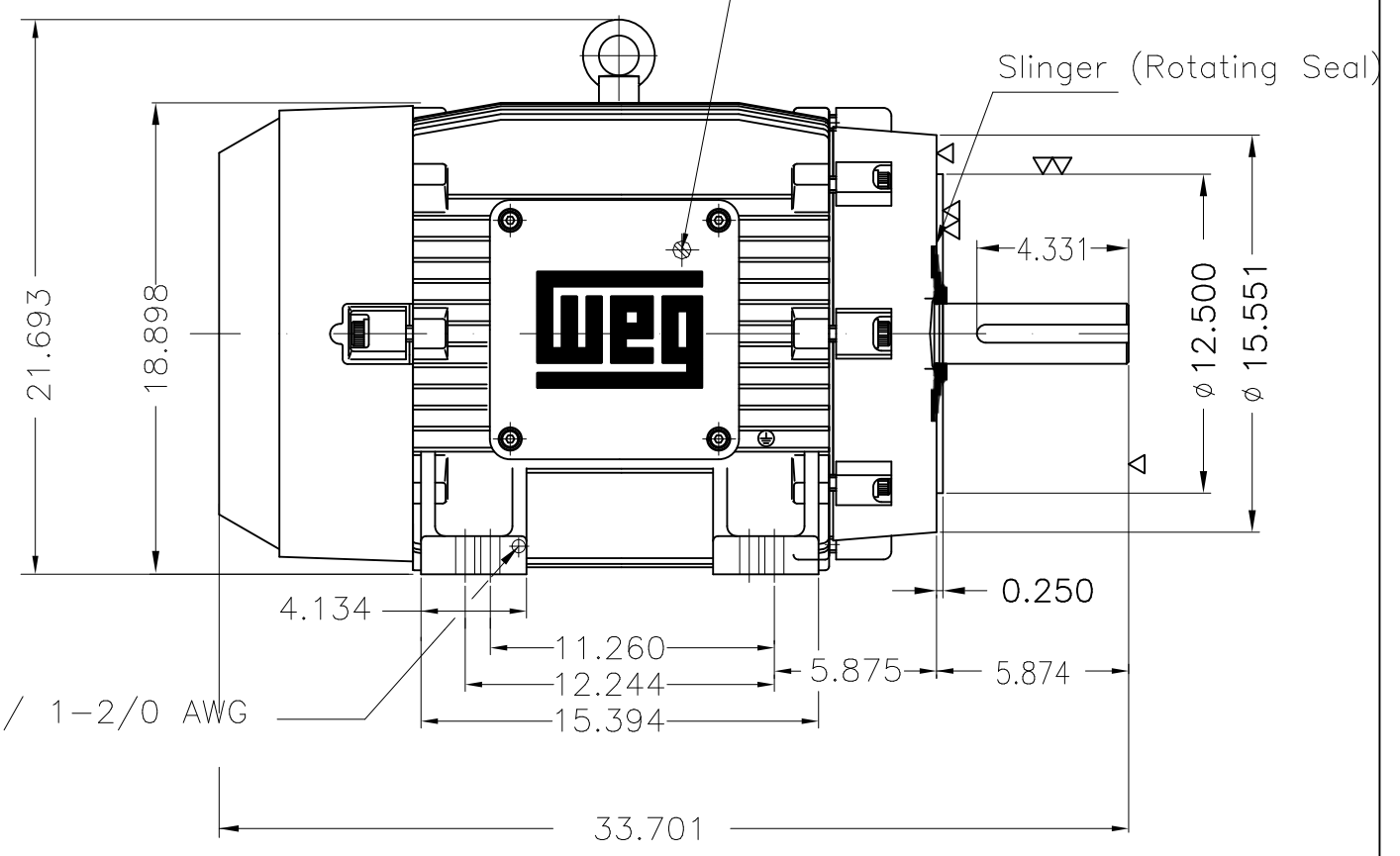

C

D

E

Color RAL 5009
 Painting plan 222P
 Mounting NEMA F-1
 Mounting B34R(D)

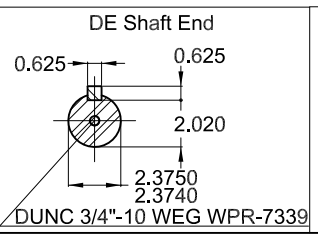

60 HP 04 Poles 60 Hz A

ECM		LOC	SUMMARY OF MODIFICATIONS		HYBRISUSER					00
EXECUTED	HYBRISUSER		THREE PH. MOTOR EXPLOSION PROOF NEMA PREM. EFF.		EXECUTED	CHECKED	RELEASED	DATE	VER	
CHECKED			FRAME 364/5TC IP55 TEFC							
RELEASED										
REL. DATE		WMO	Jaragua do Sul	Product Engineering						

PREVIEW
 WDD 00
 SHEET 1 / 1

