

A

B

C

D

E

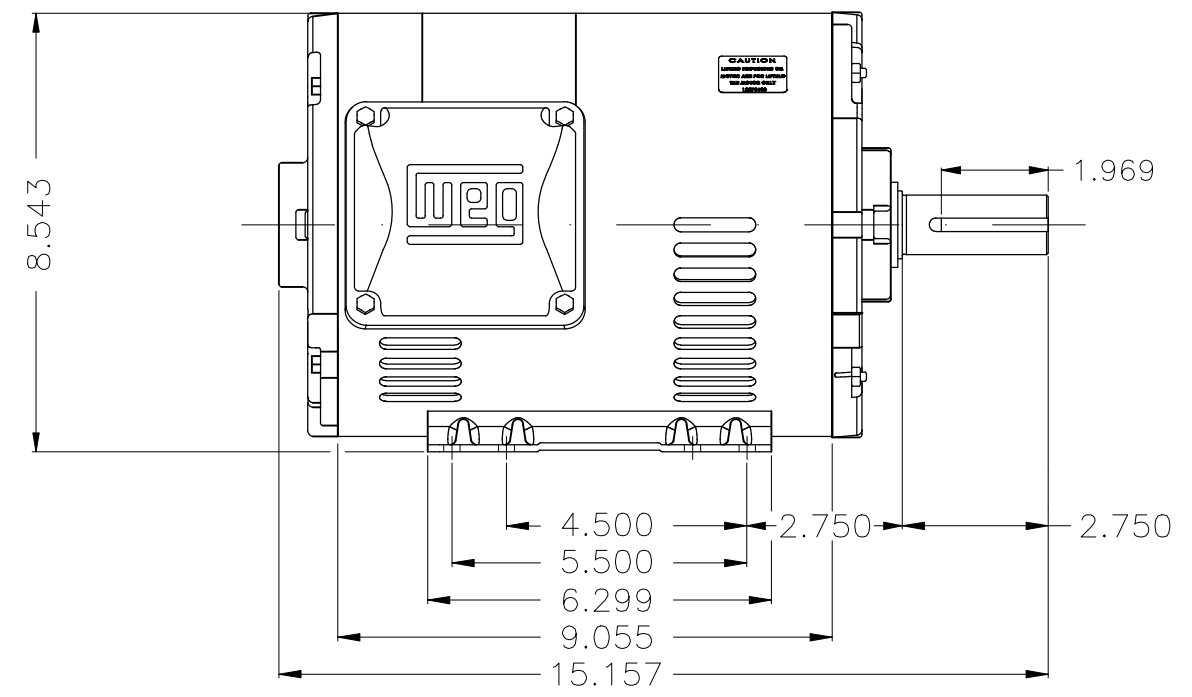
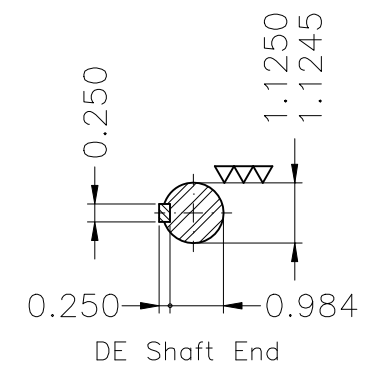
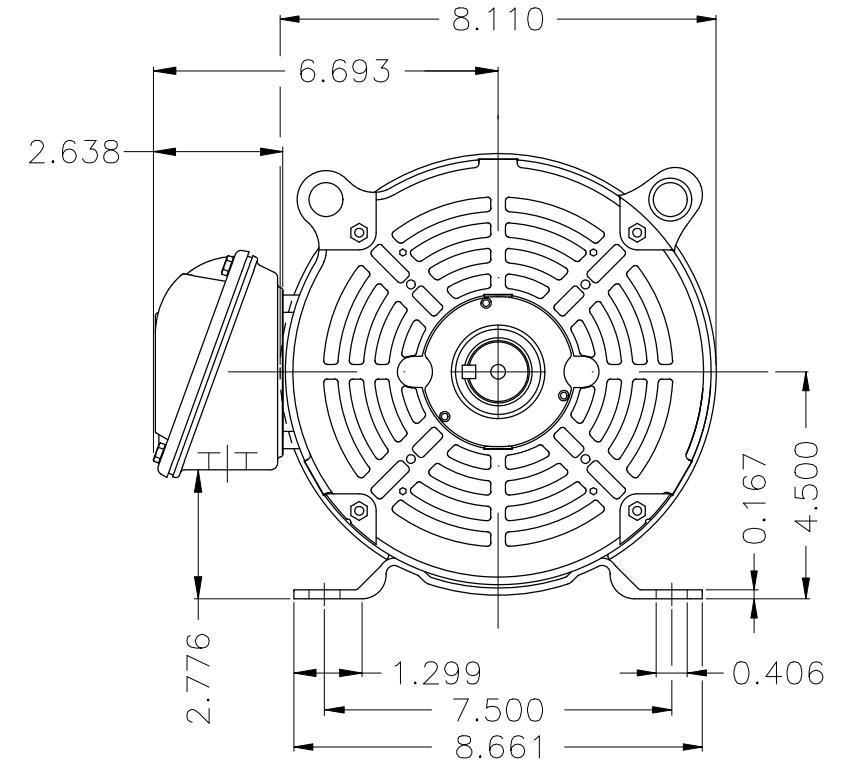
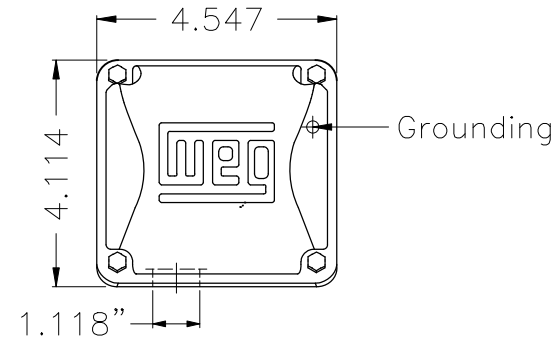

Color Munsell N 1 matte black						
Painting plan 207N						
Mounting F-1/B3R(D)						
					HYBRISUSER	00
ECM	LOC	SUMMARY OF MODIFICATIONS		EXECUTED	CHECKED	RELEASED DATE VER
EXECUTED	HYBRISUSER	THREE PH. MOTOR ROLLED STEEL NEMA PREM. EFF.			PREVIEW	
CHECKED		FRAME 182/4T IP21 ODP			WDD	00
RELEASED						
REL. DATE	WMO	Jaragua do Sul	Product Engineering	SHEET	1 / 1	

3 HP 04 Poles 60 Hz

A

