

DATA SHEET



Three Phase Induction Motor - Squirrel Cage

Customer :

Product line : W22 IEEE 841 NEMA Premium Efficiency Three-Phase Product code : 11939518

Frame	: 182/4TC	Cooling method	: IC411 - TEFC
Insulation class	: F	Mounting	: F-1
Duty cycle	: Cont.(S1)	Rotation ¹	: Both (CW and CCW)
Ambient temperature	: -20°C to +40°C	Starting method	: Direct On Line
Altitude	: 1000 m.a.s.l.	Approx. weight ²	: 51.5 kg
Protection degree	: IP55	Moment of inertia (J)	: 0.0094 kgm ²
Design	: B		

Output [HP]	5	4	4	4	5	5	5
Poles	2	2	2	2	2	2	2
Frequency [Hz]	60	50	50	50	50	50	50
Rated voltage [V]	460	380	400	415	380	400	415
Rated current [A]	5.90	5.79	5.57	5.43	7.14	6.78	6.61
L. R. Amperes [A]	44.8	42.8	45.1	48.3	42.1	44.7	47.6
LRC [A]	7.6x(Code J)	7.4x(Code H)	8.1x(Code J)	8.9x(Code K)	5.9x(Code F)	6.6x(Code G)	7.2x(Code H)
No load current [A]	2.00	2.00	2.15	2.25	2.00	2.15	2.25
Rated speed [RPM]	3485	2890	2900	2910	2850	2870	2880
Slip [%]	3.19	3.67	3.33	3.00	5.00	4.33	4.00
Rated torque [kgfm]	1.04	1.00	1.00	0.998	1.27	1.26	1.26
Locked rotor torque [%]	229	229	270	300	180	210	240
Breakdown torque [%]	350	320	370	400	250	290	320
Service factor	1.25	1.25	1.25	1.25	1.25	1.25	1.25
Temperature rise	80 K	80 K	80 K	80 K	80 K	80 K	80 K
Locked rotor time	45s (cold) 25s (hot)	32s (cold) 18s (hot)	32s (cold) 18s (hot)	32s (cold) 18s (hot)	32s (cold) 18s (hot)	32s (cold) 18s (hot)	32s (cold) 18s (hot)
Noise level ²	66.0 dB(A)	62.0 dB(A)	62.0 dB(A)	62.0 dB(A)	62.0 dB(A)	62.0 dB(A)	62.0 dB(A)
Efficiency (%)	25%						
	50%	86.5	86.3	86.3	86.1	87.5	87.5
	75%	88.5	87.7	88.2	88.2	87.5	88.5
	100%	88.5	87.5	88.3	88.3	86.5	87.5
Power Factor	25%						
	50%	0.76	0.74	0.71	0.68	0.81	0.78
	75%	0.85	0.85	0.83	0.81	0.88	0.87
	100%	0.89	0.90	0.88	0.87	0.91	0.90

Losses at normative operating points (speed;torque), in percentage of rated output power

Losses (%)	P1 (0,9;1,0)	12.4	12.4	12.4	12.4	12.4	12.4
	P2 (0,5;1,0)	9.9	9.9	9.9	9.9	9.9	9.9
	P3 (0,25;1,0)	8.9	8.9	8.9	8.9	8.9	8.9
	P4 (0,9;0,5)	6.2	6.2	6.2	6.2	6.2	6.2
	P5 (0,5;0,5)	3.7	3.7	3.7	3.7	3.7	3.7
	P6 (0,5;0,25)	2.3	2.3	2.3	2.3	2.3	2.3
	P7 (0,25;0,25)	1.4	1.4	1.4	1.4	1.4	1.4

Bearing type	: Drive end 6207 C3 Non drive end 6206 C3	Foundation loads Max. traction : 58 kgf Max. compression : 110 kgf
Sealing	: Taconite Labyrinth Labyrinth	
Lubrication interval	: 20000 h 20000 h	
Lubricant amount	: 7 g 5 g	
Lubricant type	: Mobil Polyrex EM	

Rev.	Changes Summary	Performed	Checked	Date
Performed by				
Checked by			Page	Revision
Date	13/01/2024		1 / 9	

DATA SHEET

Three Phase Induction Motor - Squirrel Cage



Customer : _____

Notes

Rev.	Changes Summary	Performed	Checked	Date
Performed by				
Checked by			Page	Revision
Date	13/01/2024		2 / 9	

LOAD PERFORMANCE CURVE

Three Phase Induction Motor - Squirrel Cage



Customer : _____

Product line : W22 IEEE 841 NEMA Premium Efficiency
Three-Phase

Product code : 11939518

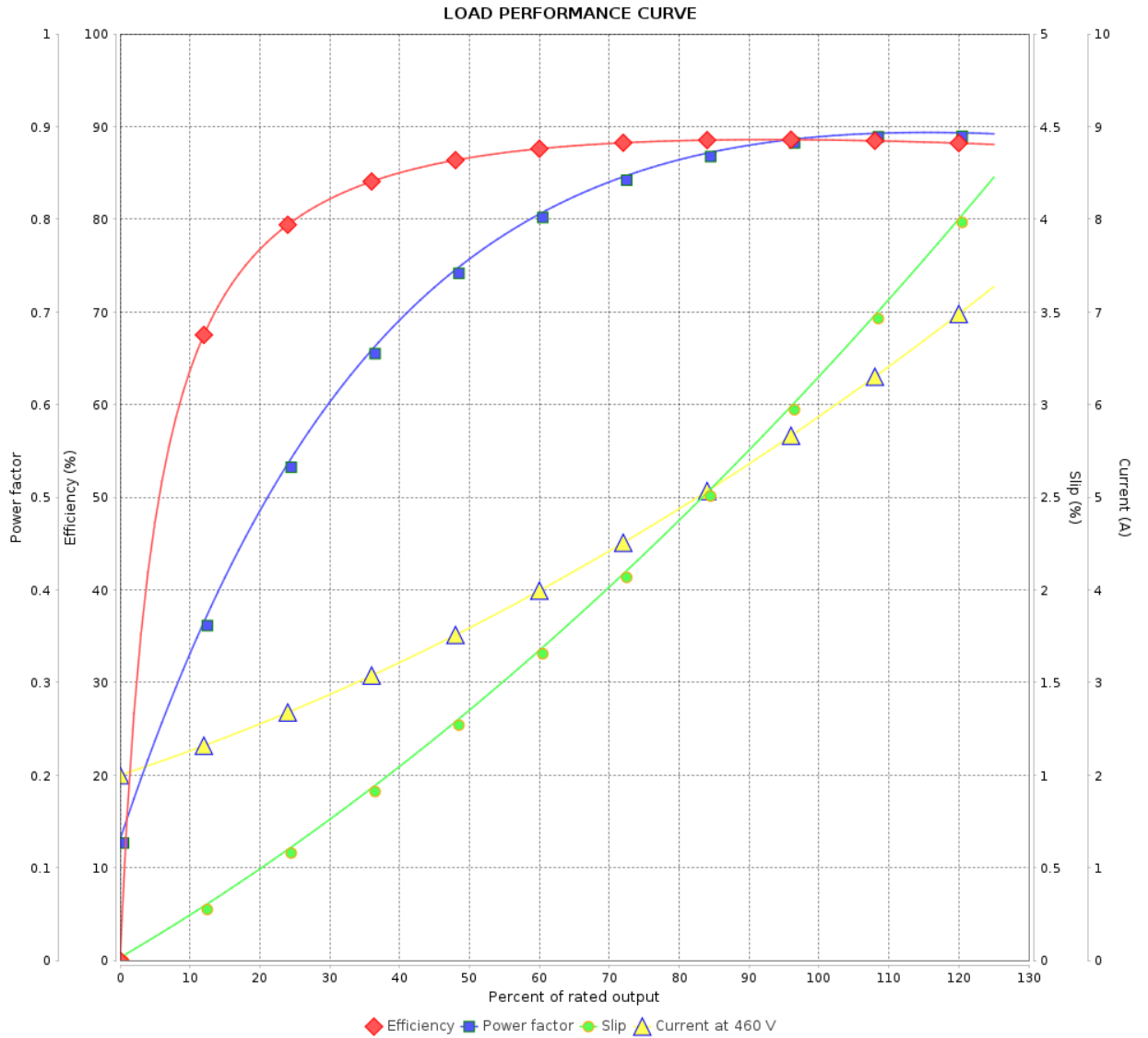

Performance : 460 V 60 Hz 2P

Rated current : 5.90 A
 LRC : 7.6
 Rated torque : 1.04 kgfm
 Locked rotor torque : 229 %
 Breakdown torque : 350 %
 Rated speed : 3485 rpm

Moment of inertia (J) : 0.0094 kgm²
 Duty cycle : Cont.(S1)
 Insulation class : F
 Service factor : 1.25
 Temperature rise : 80 K
 Design : B

Rev.	Changes Summary	Performed	Checked	Date
Performed by			Page	Revision
Checked by				
Date				
			3 / 9	

LOAD PERFORMANCE CURVE

Three Phase Induction Motor - Squirrel Cage



Customer : _____

Product line : W22 IEEE 841 NEMA Premium Efficiency Three-Phase Product code : 11939518

LOAD PERFORMANCE CURVE

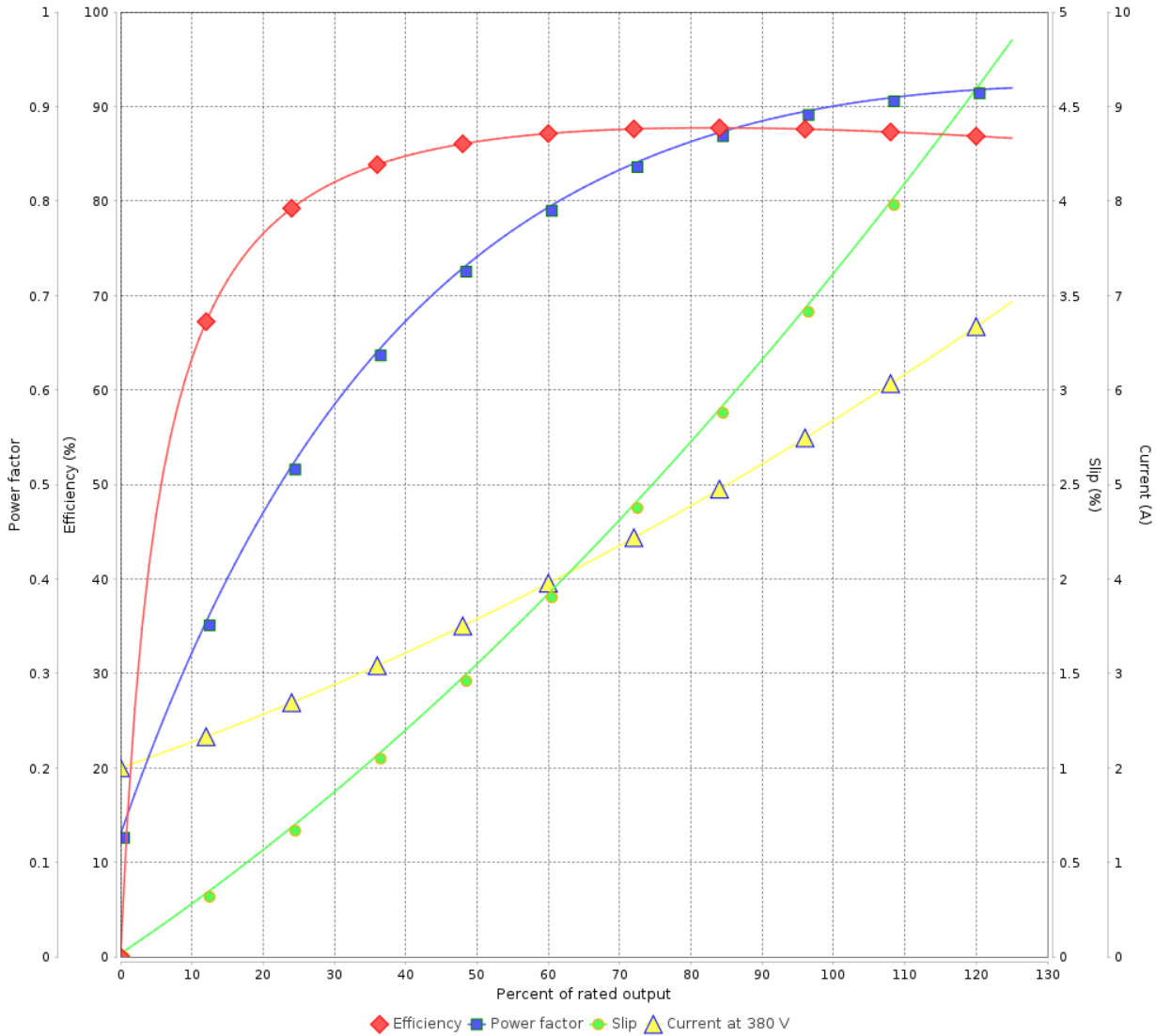

Performance : 380 V 50 Hz 2P IE3

Rated current	: 5.79 A	Moment of inertia (J)	: 0.0094 kgm ²
LRC	: 7.4	Duty cycle	: Cont.(S1)
Rated torque	: 1.00 kgfm	Insulation class	: F
Locked rotor torque	: 229 %	Service factor	: 1.25
Breakdown torque	: 320 %	Temperature rise	: 80 K
Rated speed	: 2890 rpm	Design	: B

Rev.	Changes Summary	Performed	Checked	Date
Performed by			Page	Revision
Checked by			4 / 9	
Date	13/01/2024			

LOAD PERFORMANCE CURVE

Three Phase Induction Motor - Squirrel Cage



Customer :

Product line : W22 IEEE 841 NEMA Premium Efficiency Three-Phase

Product code : 11939518

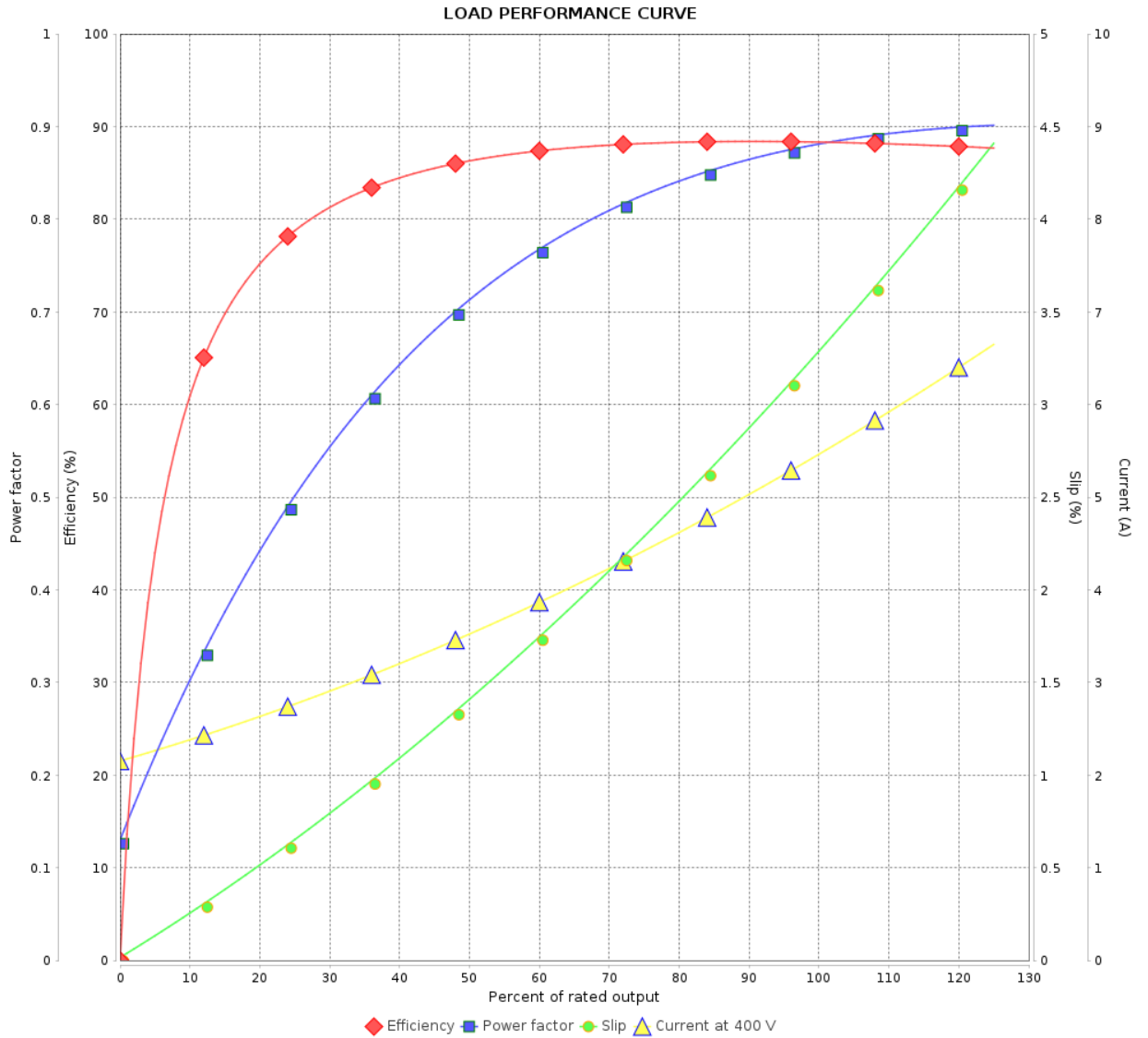

Performance : 400 V 50 Hz 2P IE3

Rated current : 5.57 A
 LRC : 8.1
 Rated torque : 1.00 kgfm
 Locked rotor torque : 270 %
 Breakdown torque : 370 %
 Rated speed : 2900 rpm

Moment of inertia (J) : 0.0094 kgm²
 Duty cycle : Cont.(S1)
 Insulation class : F
 Service factor : 1.25
 Temperature rise : 80 K
 Design : B

Rev.	Changes Summary	Performed	Checked	Date
Performed by		Page		Revision
Checked by		5 / 9		
Date		13/01/2024		

LOAD PERFORMANCE CURVE

Three Phase Induction Motor - Squirrel Cage



Customer :

Product line : W22 IEEE 841 NEMA Premium Efficiency Three-Phase Product code : 11939518

LOAD PERFORMANCE CURVE

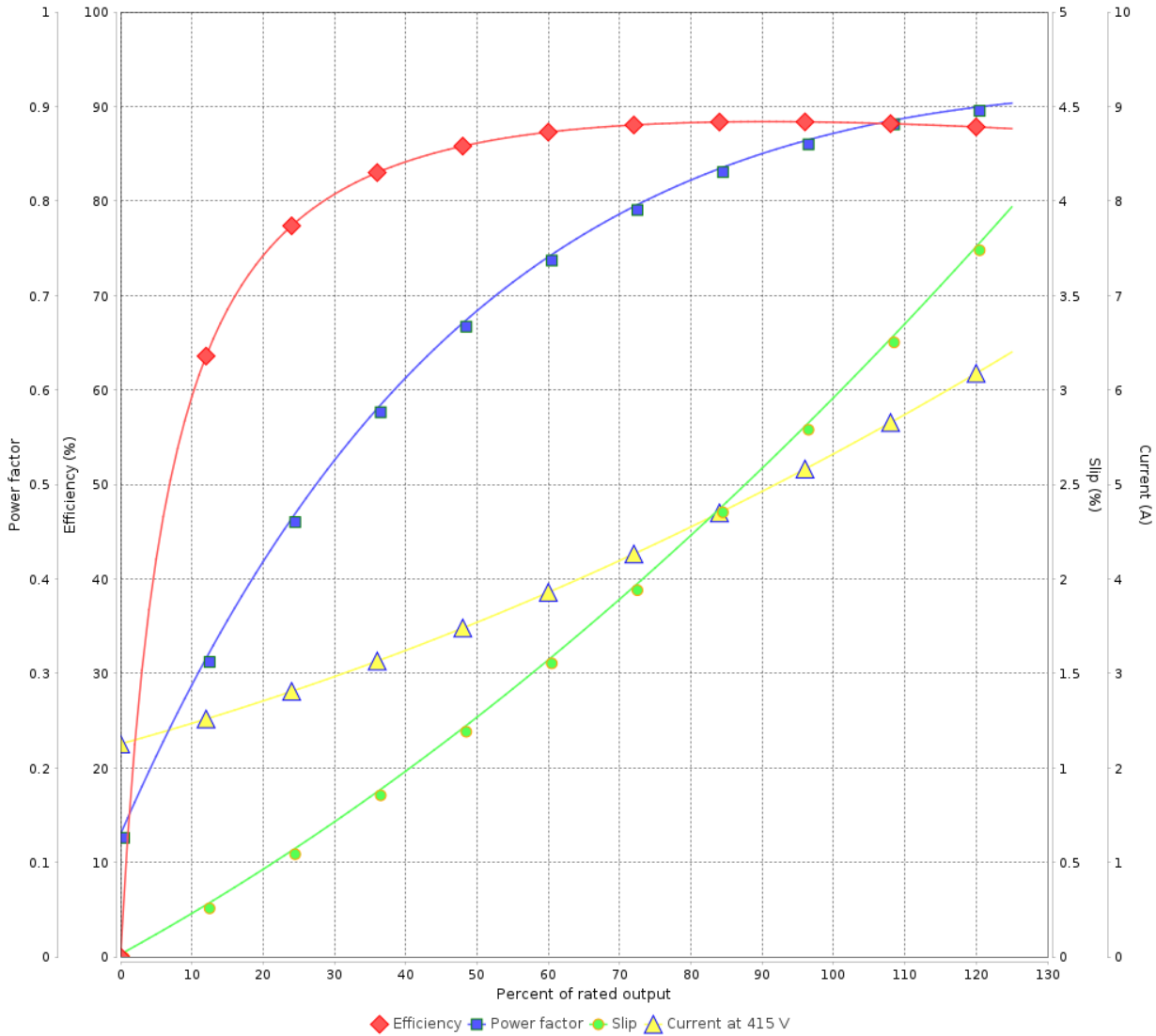

Performance : 415 V 50 Hz 2P IE3

Rated current	: 5.43 A	Moment of inertia (J)	: 0.0094 kgm ²
LRC	: 8.9	Duty cycle	: Cont.(S1)
Rated torque	: 0.998 kgfm	Insulation class	: F
Locked rotor torque	: 300 %	Service factor	: 1.25
Breakdown torque	: 400 %	Temperature rise	: 80 K
Rated speed	: 2910 rpm	Design	: B

Rev.	Changes Summary	Performed	Checked	Date
Performed by			Page	Revision
Checked by			6 / 9	
Date	13/01/2024			

LOAD PERFORMANCE CURVE

Three Phase Induction Motor - Squirrel Cage



Customer :

Product line : W22 IEEE 841 NEMA Premium Efficiency Three-Phase

Product code : 11939518

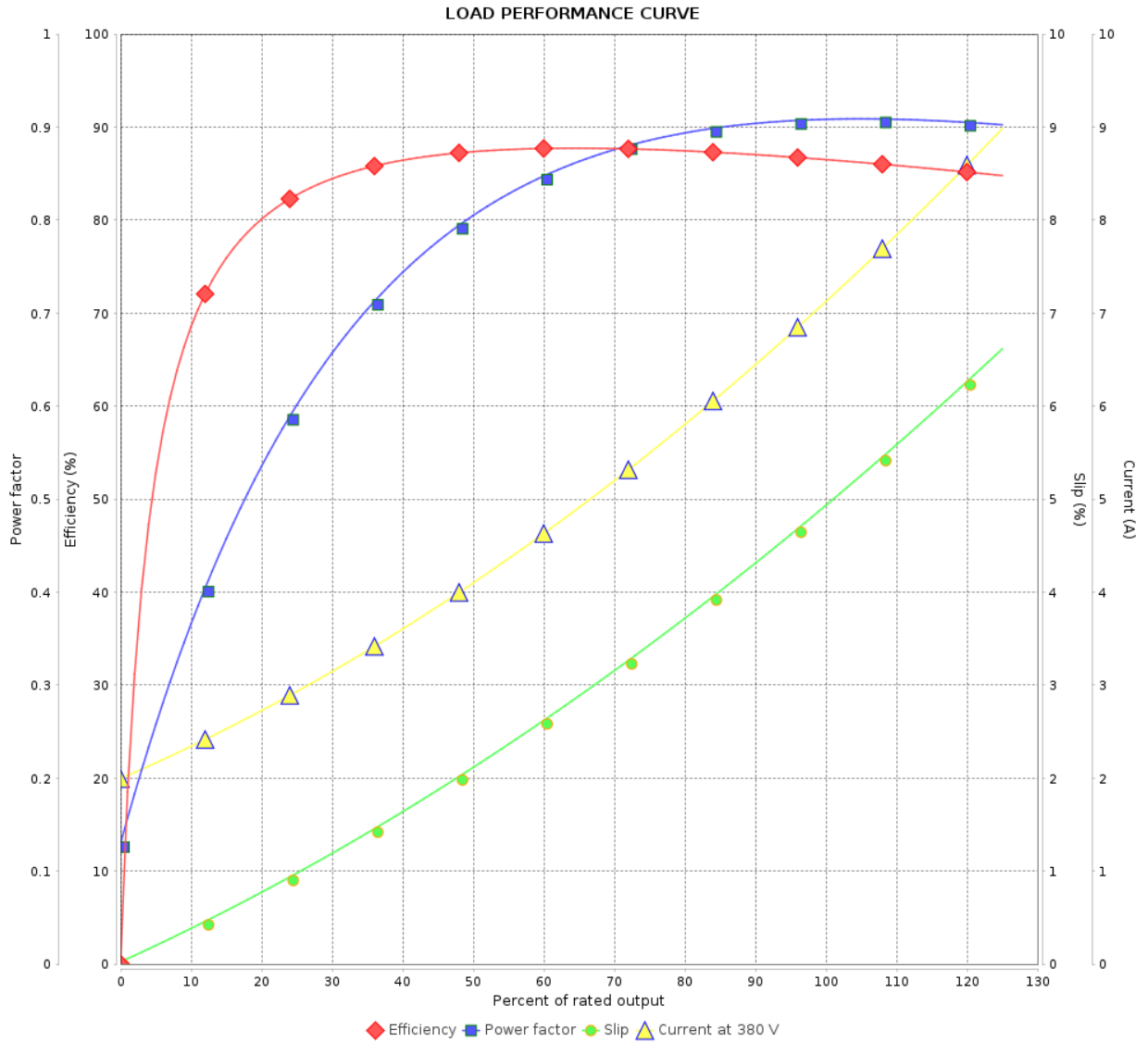

Performance : 380 V 50 Hz 2P IE2

Rated current : 7.14 A
 LRC : 5.9
 Rated torque : 1.27 kgfm
 Locked rotor torque : 180 %
 Breakdown torque : 250 %
 Rated speed : 2850 rpm

Moment of inertia (J) : 0.0094 kgm²
 Duty cycle : Cont.(S1)
 Insulation class : F
 Service factor : 1.25
 Temperature rise : 80 K
 Design : B

Rev.	Changes Summary	Performed	Checked	Date
Performed by			Page 7 / 9	Revision
Checked by				
Date	13/01/2024			

LOAD PERFORMANCE CURVE

Three Phase Induction Motor - Squirrel Cage



Customer :

Product line : W22 IEEE 841 NEMA Premium Efficiency Three-Phase Product code : 11939518

LOAD PERFORMANCE CURVE

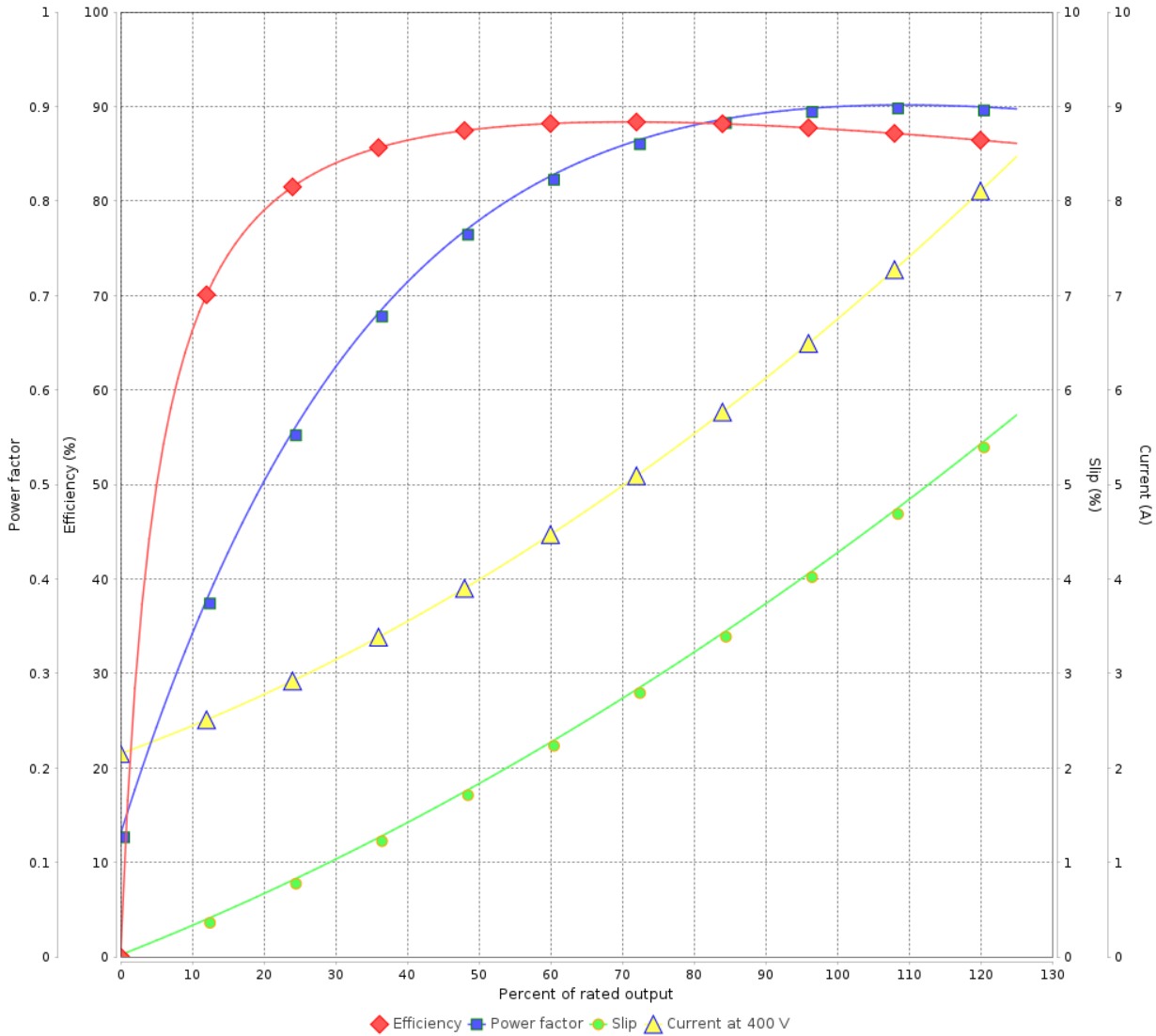

Performance : 400 V 50 Hz 2P IE2

Rated current	: 6.78 A	Moment of inertia (J)	: 0.0094 kgm ²
LRC	: 6.6	Duty cycle	: Cont.(S1)
Rated torque	: 1.26 kgfm	Insulation class	: F
Locked rotor torque	: 210 %	Service factor	: 1.25
Breakdown torque	: 290 %	Temperature rise	: 80 K
Rated speed	: 2870 rpm	Design	: B

Rev.	Changes Summary	Performed	Checked	Date
Performed by			Page	Revision
Checked by			8 / 9	
Date	13/01/2024			

LOAD PERFORMANCE CURVE

Three Phase Induction Motor - Squirrel Cage



Customer : _____

Product line : W22 IEEE 841 NEMA Premium Efficiency
Three-Phase

Product code : 11939518

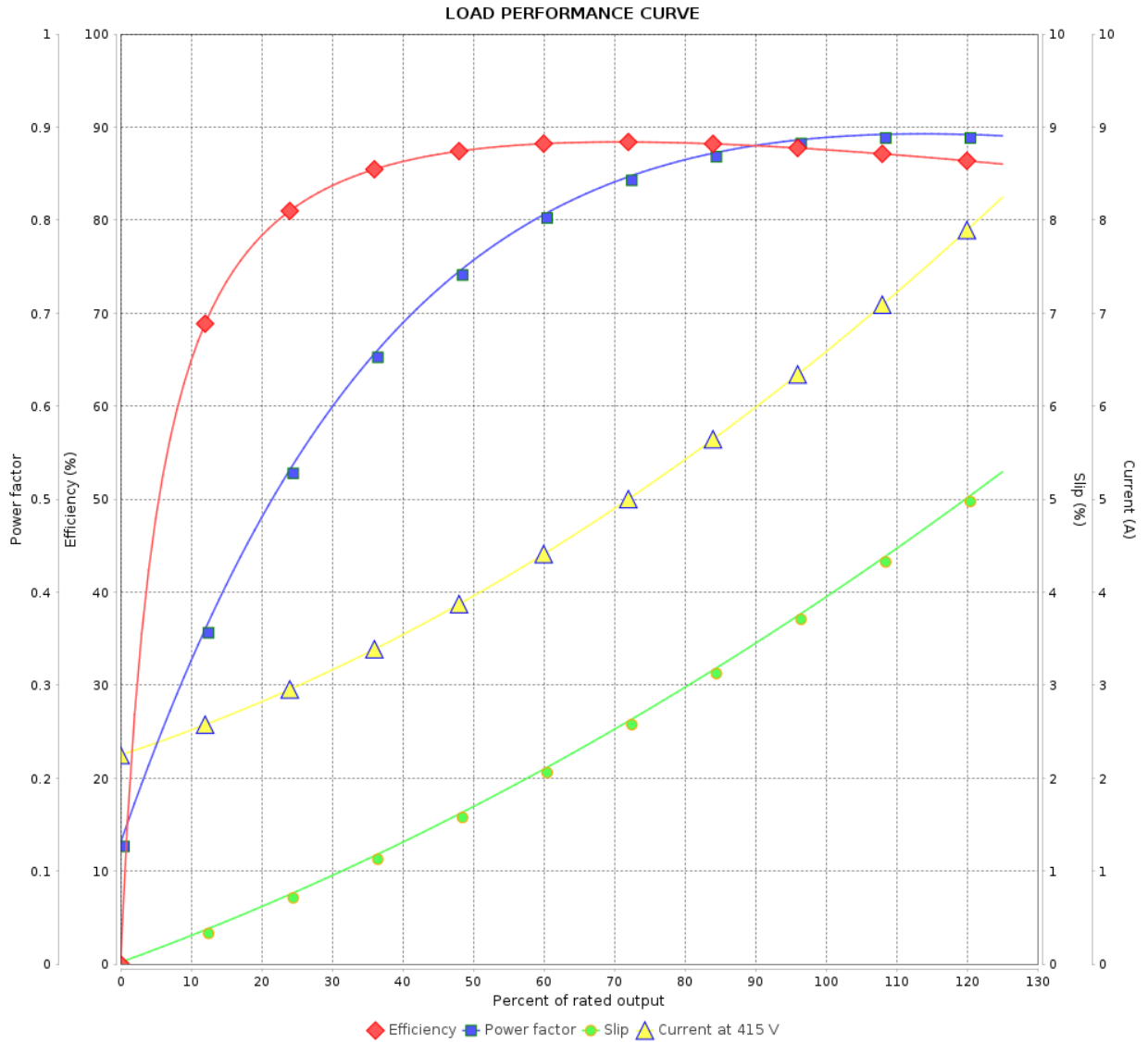

Performance : 415 V 50 Hz 2P IE2

Rated current : 6.61 A
 LRC : 7.2
 Rated torque : 1.26 kgfm
 Locked rotor torque : 240 %
 Breakdown torque : 320 %
 Rated speed : 2880 rpm

Moment of inertia (J) : 0.0094 kgm²
 Duty cycle : Cont.(S1)
 Insulation class : F
 Service factor : 1.25
 Temperature rise : 80 K
 Design : B

Rev.	Changes Summary	Performed	Checked	Date
Performed by			Page	Revision
Checked by				
Date				

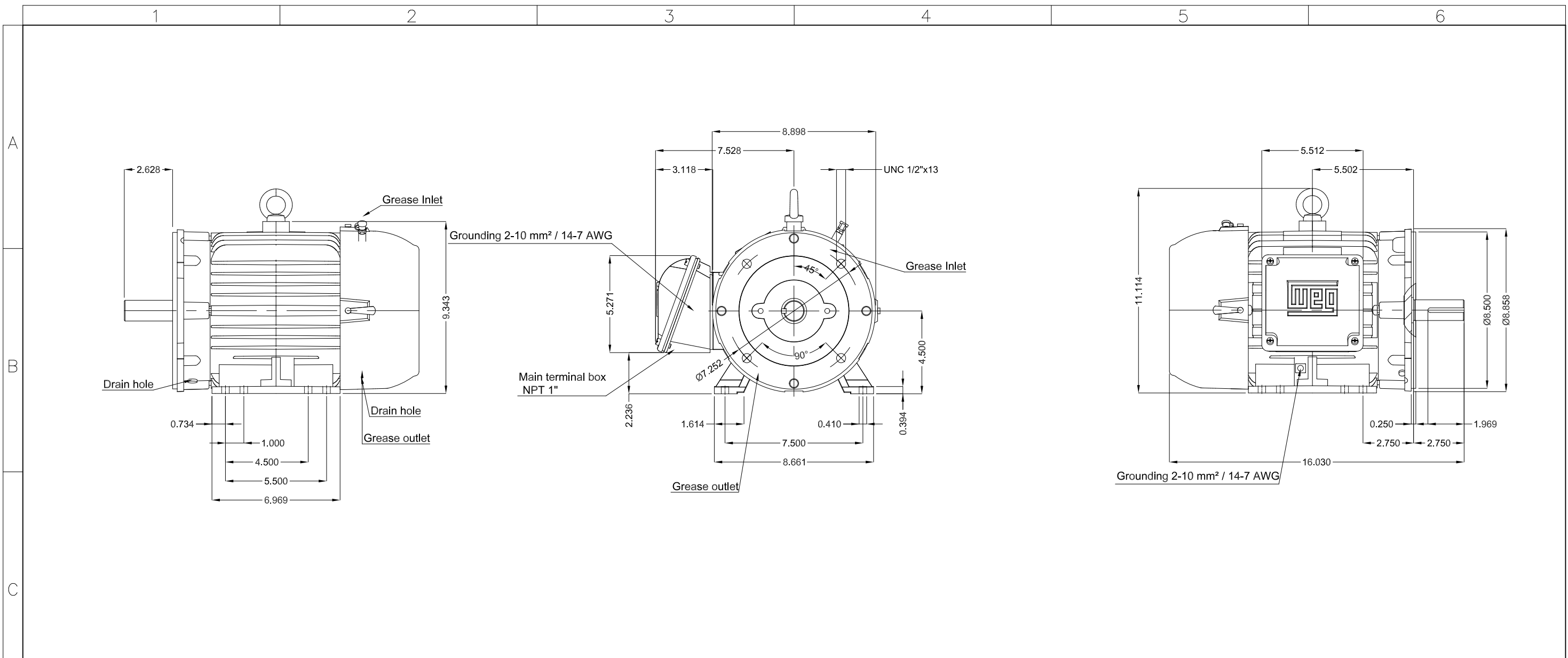

A

B

C

D

E

Sealing - Taconite labyrinth

Grease outlet according to IEEE841

Color RAL 5009

Painting plan 202E

Mounting B34R(D)

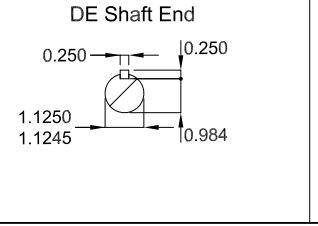

5 HP 02 Poles 60 Hz										A	
HYBRISUSER										00	
ECM	LOC	SUMMARY OF MODIFICATIONS					EXECUTED	CHECKED	RELEASED	DATE	VER
EXECUTED	HYBRISUSER	THREE PH. MOTOR IEEE 841 W22 NEMA PREM. EFF.					<p>PREVIEW</p> <p>WDD 00</p> <p>SHEET /</p> 				
CHECKED		FRAME 182/4TC IP55 TEFC									
RELEASED											
REL. DATE											