

1 2 3 4 5 6

A

B

C

D

E

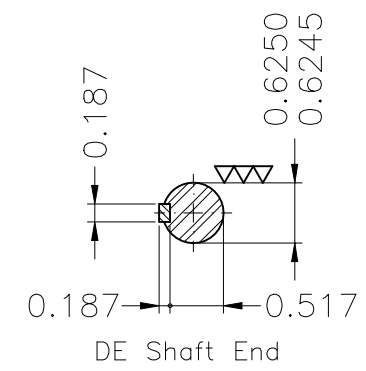
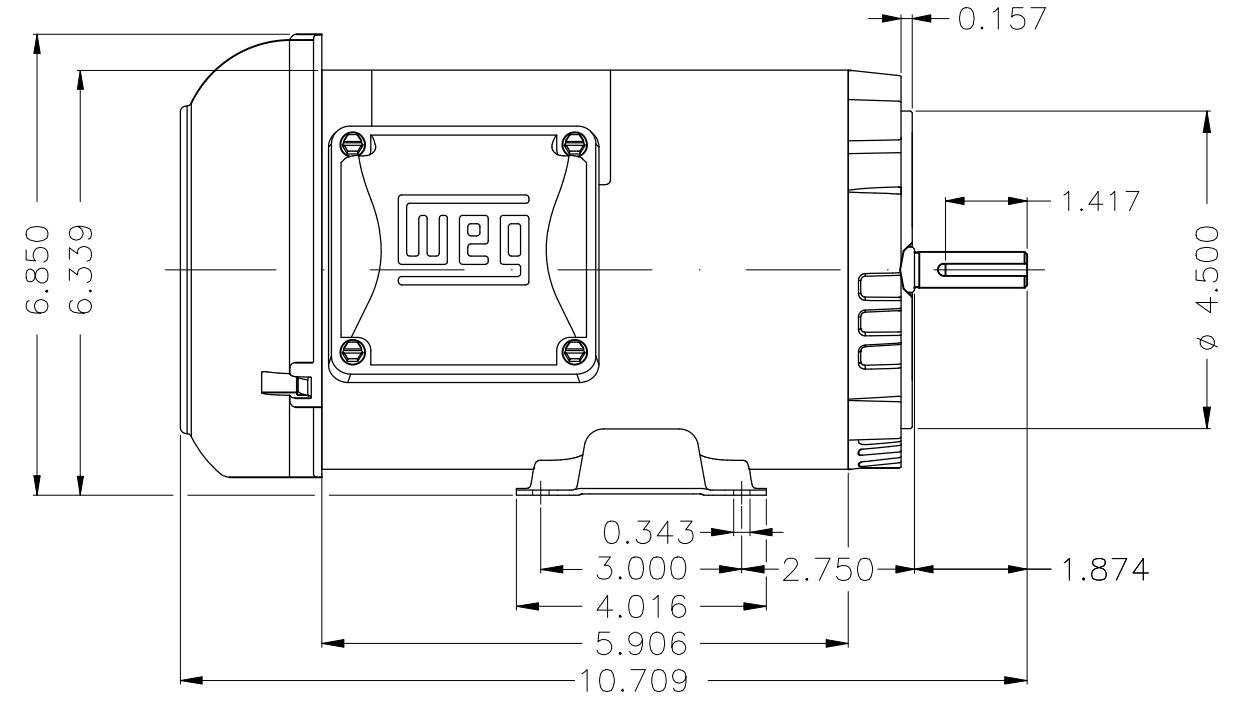
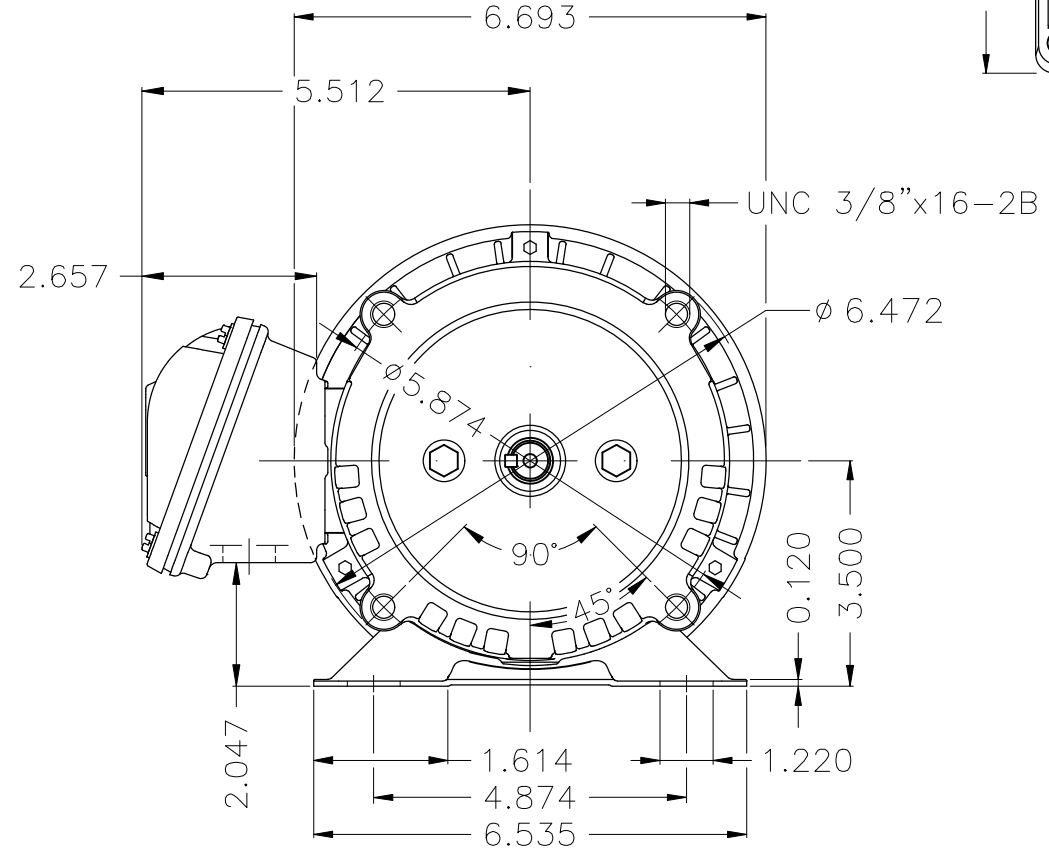
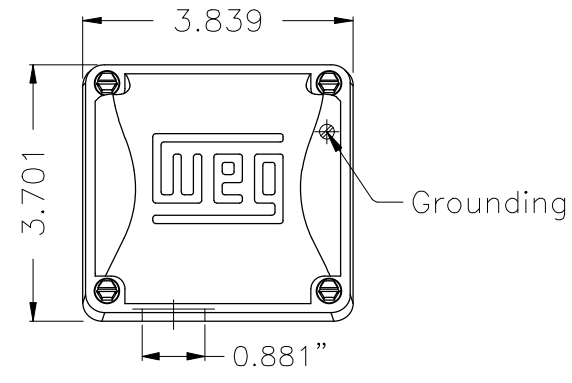

Color Munsell N 1 matte black
 Painting plan 207N
 Mounting B34D

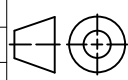
ECM	LOC	SUMMARY OF MODIFICATIONS	EXECUTED	CHECKED	RELEASED	DATE	VER
EXECUTED	HYBRISUSER	 THREE PH. MOTOR ROLLED STEEL PREM. EFF. FRAME W56C IP55 TEFC					
CHECKED							
RELEASED							
REL. DATE	WMO	Jaragua do Sul	Product Engineering	HYBRISUSER	WDD	00	00

0.75 HP 02 Poles 60 Hz

A SHEET 1 / 1

